

INSTALLATION INSTRUCTIONS FOR:

MST/XXX-120-SP-#-XX	Split Phase 3 Wire + Gnd
MST/XXX-240-2P-0-XX	Single Phase 2 Wire + Gnd
MST/XXX-120-3W-#-XX	3 Phase Wye, 4 Wire + Gnd
MST/XXX-120-3H-#-XX	High Leg 4 Wire + Gnd
MST/XXX-240-3D-0-XX	3 Phase Delta, 3 Wire + Gnd
MST/XXX-220-3W-#-XX	3 Phase Wye, 4 Wire + Gnd
MST/XXX-230-3W-#-XX	3 Phase Wye, 4 Wire + Gnd
MST/XXX-240-3W-#-XX	3 Phase Wye, 4 Wire + Gnd
MST/XXX-277-3W-#-XX	3 Phase Wye, 4 Wire + Gnd
MST/XXX-480-2P-0-XX	Single Phase 2 Wire + Gnd
MST/XXX-480-3D-0-XX	3 Phase Delta, 3 Wire + Gnd

Replace XXX with desired kA Rating. Replace # with F for optional Filtering.
Replace XX for NEMA Enclosures 3R, 12 or SS (Stainless Steel).

The above MST Series incorporates the MT Series of protection modules. Keyed to prevent their misapplication, the MT Series of modules fit into their touch-safe assembly only if they are a safe match. Although it is possible to insert a higher voltage rated module into a lesser rated dead-front assembly it is not possible, without sever physical alteration of the device, to insert a lesser rated module into a higher rated touch-safe assembly.

1) Secondary Surge Arrestors listed to UL OWHX can be directly connected across the load side of the meter can or at the line side of the main breaker.

2) TVSS devices listed to UL 1449 may be fed from a 20Amp or 30Amp Breaker in a breaker or distribution panel.

3) Optimize device performance by keeping connecting wires as short and as straight as possible. Plan the wiring path(s) prior to commencing any installation procedure. This will assist in keeping the wire lengths and inductance to a minimum.

SECURE ALL POWER FROM THE PANEL TO WHICH THE DEVICE IS BEING INSTALLED.

Mount the SPD using the four (4) mounting holes in the enclosure(s).

ENSURE ALL CONNECTIONS ARE CORRECT AND SECURE BEFORE ENERGIZING SPD.

UNIT DIAGNOSTICS

PHASE LED(S): When the SPD is securely connected and operating properly, the RED LEDs will be illuminated. Replacement of the SPD is required if the RED LED(S) are not illuminated.

MAINTENANCE:

Check the status of the LED indicators at intervals not to exceed 2 months. If the Indicators are not illuminated the Protector requires replacement.

PLEASE NOTE:
EXCEPT FOR MT MODULE REPLACEMENTS THERE ARE NO USER SERVICEABLE PARTS INSIDE.

WARRANTY INFORMATION

Meter-Treater, Inc. (MTI) warrants all MST Series models to be free from defects, and will at our option repair or replace the product should it fail within fifteen (15) years from the first date of shipment. This warranty is limited to defects in workmanship or materials, and does not cover customer damage, abuse or unauthorized modification. If this product fails or does not perform as warranted, your sole recourse shall be repair or replacement as described above. Under no condition shall MTI be liable for any damages incurred by the use of this product. Damages include, but are not limited to, the following: lost profits, lost savings and incidental or consequential damages arising from the use of or inability to use this product. MTI specifically disclaims all other warranties, expressed or implied, and the installation or use of this product shall be deemed an acceptance of these terms by the user.

WARRANTY RETURNS

All warranty and non-warranty repairs must be returned freight prepaid and insured to MTI. All returns must have a Return Authorization (RA) number on the outside of the shipping container. This number may be obtained from MTI Warranty Department at (800) 342-6890. Products returned without an RA number will not be accepted.

NOTE

IF UNIT(S) ARE RECEIVED DAMAGED,
NOTIFY THE SHIPPING COMPANY IMMEDIATELY.
RETAIN ALL SHIPPING CONTAINERS AND PACKING
MATERIALS FOR INSPECTION.

PRODUCT INFORMATION

MODEL #: _____

SERIAL #: _____

MANUFACTURED DATE: _____

QA Sign Off: _____

Meter-Treater, Inc.

1349 South Killian Drive, Lake Park, Florida 33403

Phone: (561) 845-2007 Fax: (561) 848-2372

e-mail: sales@metertreater.com

Website: www.metertreater.com

MST SERIES



**SURGE PROTECTION DEVICES
FOR
AC POWER APPLICATIONS**

USER MANUAL AND INSTALLATION GUIDE (ALL MODELS)



The MST Series built to ETL Listed 1449
3rd Edition Type 1 and Type 2.



MT Modules incorporated in the MST Series are
ETL Listed to UL 1449 3rd Edition as a
Recognized Component.



P/N: 916-0001-000
MS 199-07/17/07-B

GENERAL

A) This document provides detailed information on how to install and operate the **MST Series** of Surge Protective Devices (SPD).

B) Locate a position to mount the SPD that will minimize the length of connecting wires required. SPDs should be located as close as possible to the AC panel or service area as possible. Mount the units using the mounting holes provided in the enclosure(s) as shown by the illustrations in these instructions.

C) The **MST Series** of Protectors are installed and connected in parallel ("shunt") across the AC supply to be protected. Connecting wires do not carry the supply current, only the short duration currents associated with the suppression of a transient event.

D) Identified or indicated Leads/Wires must be connected exactly with respect to the AC Power feeding the SPD. Failure to do so may result in damage to the device or pose a danger to personnel.

E) Incorrect installation may significantly impair the performance of the Surge Protective Device. It is particularly important that all installation procedures and guidelines be followed exactly.

F) **INSTALLATION OF THIS DEVICE SHOULD ONLY BE PERFORMED BY A QUALIFIED LICENSED INSTALLER.**

G) BEFORE STARTING ANY INSTALLATION PROCEDURES, VERIFY SERVICE VOLTAGES WITH AN AC VOLT-METER TO ENSURE THAT THE CORRECT SPD MODEL HAS BEEN SELECTED.

H) CHECK TO ENSURE THAT ALL CONNECTIONS ARE CORRECT AND SECURE BEFORE ENERGIZING.

I) KEEP THIS MANUAL IN A SAFE DRY PLACE FOR FUTURE REFERENCE.

FOR ASSISTANCE

CONTACT **M-TI** CUSTOMER SERVICE
AT 1-800-638-3788

MOUNTING INFORMATION

NOTE: Before starting any installation, measure the Line voltages with an AC Voltmeter to ensure the correct device has been selected for the application.

RED LEDS ARE PHASE/POWER INDICATORS

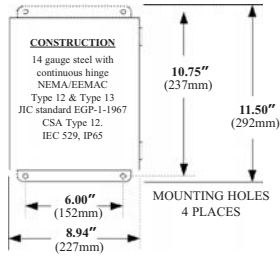

NEMA 4 / 12 enclosure.

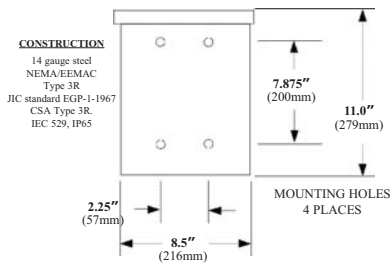

NEMA 3R enclosure.

Mount the enclosure using the four mounting holes as close as possible to the connection point into the system. Keeping the lead length short will increase the performance of the unit.

Cable penetrations may be made from any side, including the back to facilitate locating the device. Observe the open area of the backplane inside the enclosure for guidance before creating access holes.

The 3R enclosure has internal mounting holes that may be accessed by first removing the module and touch-safe cover.

The 3R enclosure must be oriented with the supplied knockouts down to allow for proper weather resistance.

Recommended Minimum Wire Sizes AWG #12
Maximum Wire Size 1/0

DO NOT CONNECT WITHOUT FIRST SECURING POWER

MT Series - Replacement Module Instructions

1. Open door on the MST enclosure and remove the MT57 Protection Module by grasping the handles and pulling the module free.
2. Insert the replacement MT Module.
3. Connect Ground wire to ground buss in the equipment panel or meter can.
4. Close door on the MST enclosure

120/240VAC, Split Phase, 3 Wire + Ground

1. Open door on the MST enclosure and remove the MT Protection Module by grasping the handles and pulling the module free.
2. Remove the touch safe cover by removing the 4 corner fasteners. Be sure to note orientation.
3. Mount the device in your predetermined location next to the panel or equipment to be protected.
4. Connect the Ground wire to the lug marked Ground in the MST unit.
5. Connect the Neutral wire to lug marked Neutral in MST unit.
6. Connect the Phase wire(s) to L1 and L2 lugs in the MST unit.
7. Replace the touch safe cover (ENSURE CORRECT ORIENTATION) and secure with fasteners.
8. Re-insert the MT Module and close the door or replace cover.
9. Connect Ground wire to ground buss in the equipment panel or meter can.
10. Connect Neutral wire to neutral buss in the equipment panel.
11. Connect Phase wire(s) to breaker(s) or load side of meter.
12. Turn on breakers (as required). LEDs should now be illuminated.

Type 2

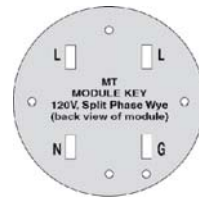
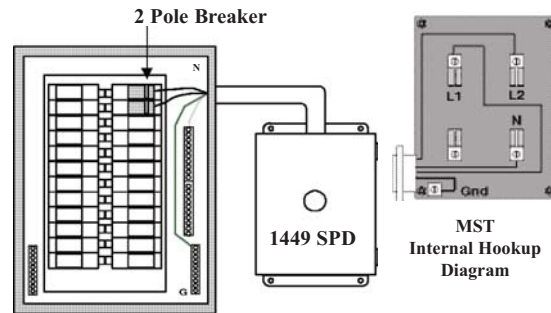

Key layouts represent the base of respective MT Replacement Modules as they interface with their appropriate dead-front counterparts. The Service Voltage determines or application or interface configuration.

The keying is the same, by voltage, for both the NEMA 3R and 12 enclosures.

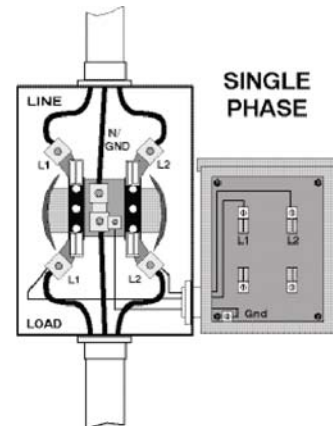

Type 1

120 Volt AC

120/240VAC, High Leg Delta, 4 Wire + Ground

120/208 or 277/480VAC, Three Phase Wye, 4 Wire + Ground

1. Open the door on the MST enclosure and remove the MT Protection Module by grasping the tabs and pulling free. Remove the green pigtail wire to completely disconnect the MT Module.
2. Remove the touch safe cover by removing the 4 corner fasteners. Be sure to note orientation.
3. Mount the device in your predetermined location next to the panel/equipment to be protected.
4. Connect the Ground wire to the lug marked Ground in the MST unit.
5. Connect the Neutral wire to lug marked Neutral in MST unit.
6. Connect the Phase wires(s) to L1, L2 & L3 lugs in the MST unit. For a High Leg Delta connect the HIGH 240V leg to the L2 lug.
7. Replace the touch safe cover (ENSURE CORRECT ORIENTATION) and secure with fasteners.
8. Connect the green pigtail wire to the MT Module.
9. Re-insert the MT Module and close the door/replace cover.
10. Connect the Ground wire to ground buss or bond to neutral / ground in the meter can.
11. Connect the Neutral (white) wire to neutral buss in the equipment panel.
12. Connect the Phase wires(s) to breakers(s) or load side of meter. For a High Leg Delta connect Phase wire from L2 to High Leg.
13. Turn on breakers (as required). The LEDs should now be illuminated.

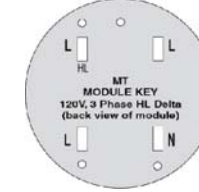
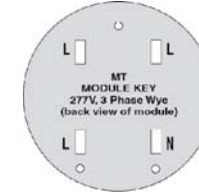
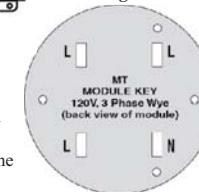
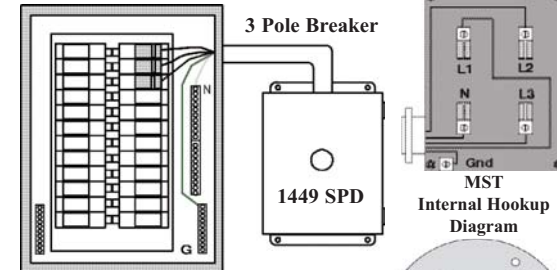

120 Volt AC 240 Volt AC 277 Volt AC

240 or 480VAC, Three Phase Delta, 3 Wire + Ground

1. Open door on the MST enclosure and remove the MT Protection Module by grasping the tabs and pulling the module free.
2. Remove the touch safe cover by removing the 4 corner fasteners. Be sure to note orientation.
3. Mount the device in your predetermined location next to the panel or equipment to be protected.
4. Connect the Ground wire to the lug marked Ground in the MST unit.
5. Connect the Phase wires(s) to the L1, L2 & L3 lugs in the MST unit.
6. Replace the touch safe cover (ENSURE CORRECT ORIENTATION) and secure with fasteners.
7. Re-insert the MT Module and close the door or replace cover.
8. Connect the Ground (green) wire to ground buss in the equipment panel or bond to neutral /ground in meter can.
9. Connect the Phase wires(s) to breakers(s) or load side of meter.
10. Turn on breakers (as required). LEDs should now be illuminated.

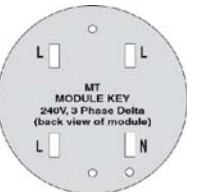
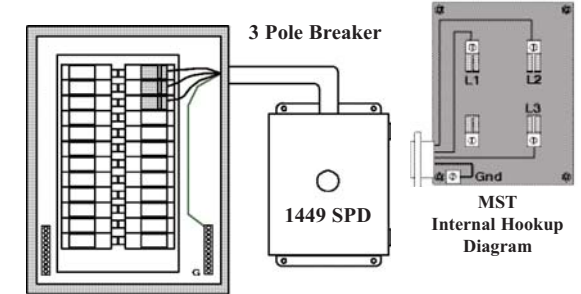

240 Volt AC 480 Volt AC

Key layouts represent the base of respective MT Replacement Modules as they interface with their appropriate dead-front counterparts. The Service Voltage determines or application or interface configuration. The keying is the same, by voltage, for both the NEMA 3R and 12 enclosures.

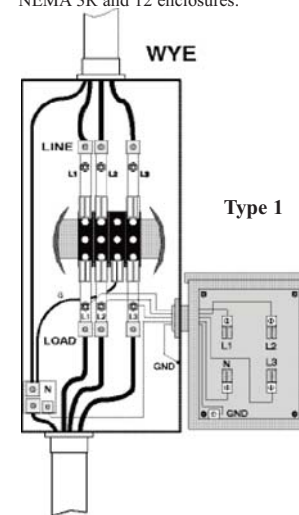

Type 1

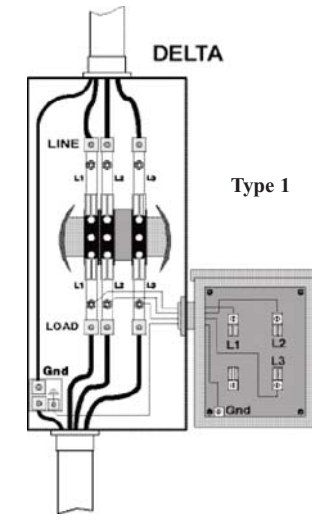

Type 1